

# S2700-B

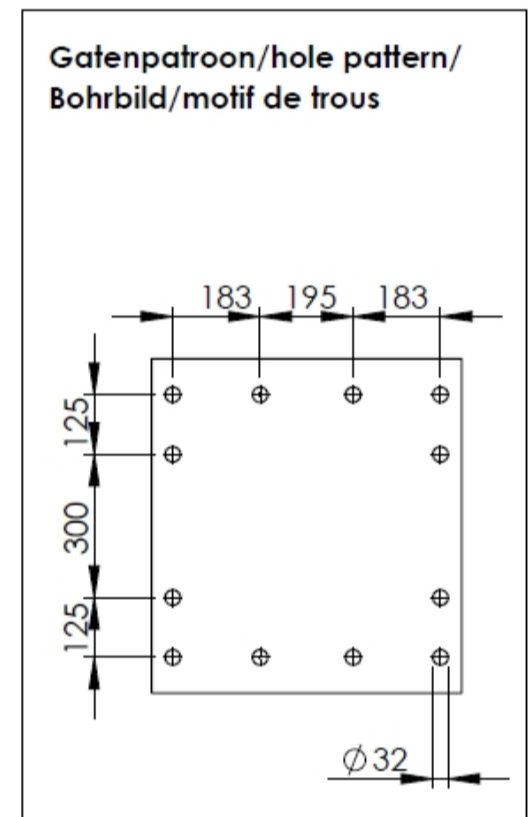

Type:  
 Boomgrijper  
 Tree grab  
 Baumgreifer mit Bügeln  
 Grappins à arbres

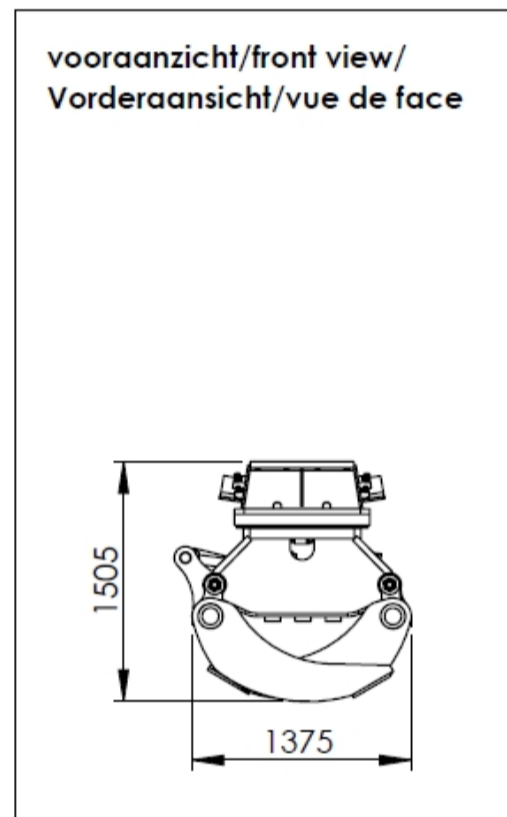
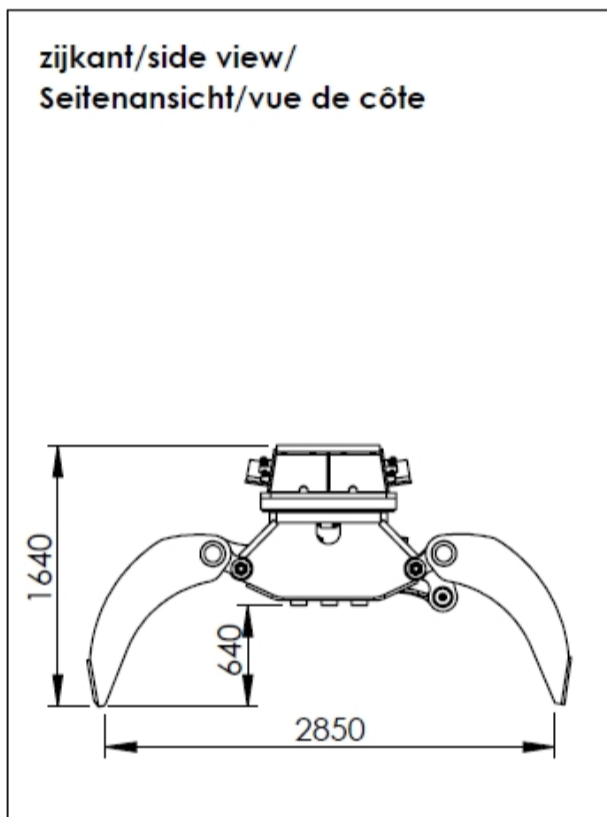
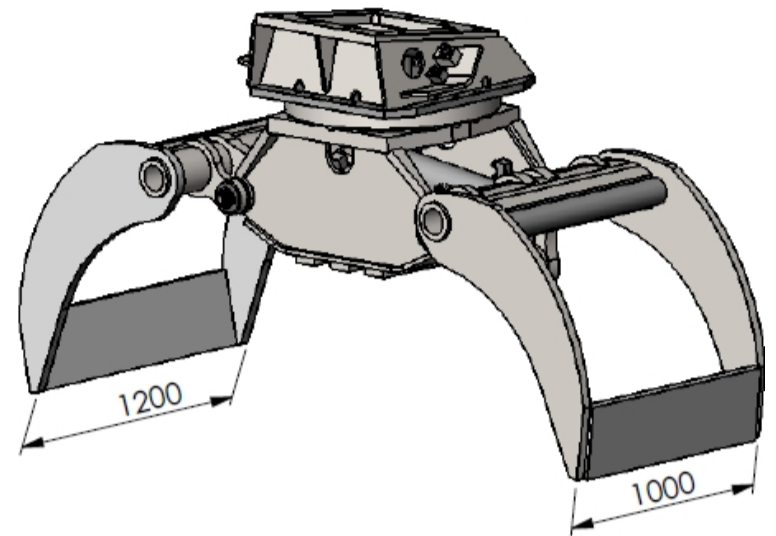

## TECHNICAL SPECIFICATIONS

Nederlands	English	Deutsch	Français		
Klasse graafmachine	Class excavator	Machine klasse	Classe de excavatrice	t	30-50
Gewicht	Weight	Gewicht	Poids	Kg	2900
Werkdruk max.	Op. pressure max	Betät. druck max	Pression maximale	bar	350
Werkdruk rotatie min.	Op. pressure rotation min	Betät. druck rotation min	Pression rotation min	bar	190
Werkdruk rotatie max	Op. pressure rotation max	Betät. druck rotation max	Pression rotation max	bar	210
Olieflow max	Oil flow max	Öfluss max	Débit d'huile max	l/min	200
Olieflow rotatie max	Oil flow rotation max	Öfluss rotation max	Débit d'huile rotation max	l/min	40
Sluitkracht	Closing force	Schliesskraft	Force de fermeture	kN	90
Slangaansluiting knijpfunctie	Hose connect open/close	Schlauchanschluss kneifen	Raccord de tuyau fermeture	-	S30
Slangaansluiting draaifunctie	Hose connect turn function	Schlauchanschluss drehen	Raccord de tuyau rotation	-	S16